

long spigot for butt- and electrofusion-welding  
 welded from pipe, non-reinforced

PP

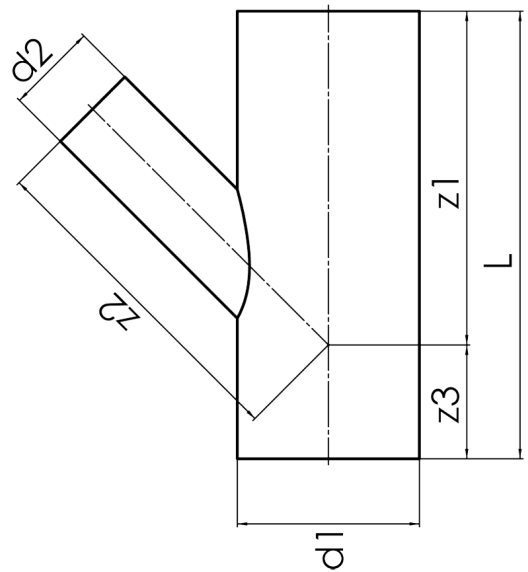

**SDR 11**

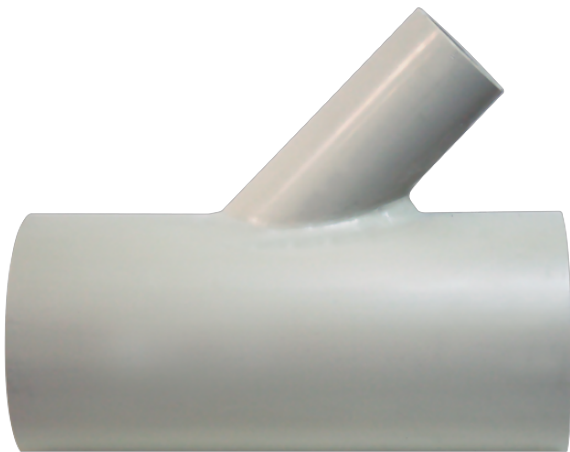

Art. No.	d1 [mm]	d2 [mm]	L [mm]	z1 [mm]	z2 [mm]	z3 [mm]	kg
22528141	280	140	750	515	515	235	15,3

Other materials, dimensions and pressure classes on request  
 tolerance + / - 2°

For questions, please feel free to contact us at: Tel. + 49 281 98 414 - 0