

Normkonform

90°

long spigot for butt- and electrofusion welding

PE 100

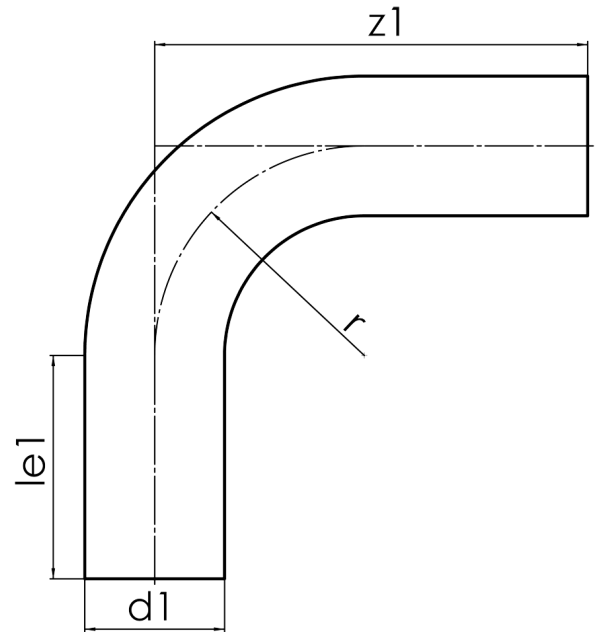

SDR 17



Art. No.	d1 [mm]	le1* [mm]	z1 [mm]	r [mm]	kg
41900061	63	100	220	95	0,3

other dimensions, materials and pressure classes on request

tolerance + / - 3°

\* minimum „le1“

For questions, please feel free to contact us at: Tel. + 49 281 98 414 - 0